

SATURN

SA-6

MISSION

SA-6 is the second of six Saturn I, Block II Launch Vehicles. It is also the sixth development flight of the planned ten Saturn I series of launch vehicles. All five Saturn I Vehicles prior to SA-6, four Block I and one Block II, were successfully launched.

The SA-6 mission is the first orbital launch of an Apollo Spacecraft by a Saturn Launch Vehicle and also the first flight utilizing an active ST-124 Stabilized Platform. The Apollo Spacecraft is composed of a Launch Escape System (LES) with a live jettison motor, a heavy walled Command Module (CM), and a Service Module (SM). Jettison of the LES will occur after engine ignition of the S-IV Stage. The S-IV Second Stage, Instrumentation Unit, and Apollo Spacecraft (less the LES) will be injected into a near circular earth orbit as a single body. The total weight in orbit will be approximately 38,000 pounds. Nominal orbital life of the payload should be several orbits and re-entry by random orbital decay with no planned recovery. The payload will be continuously tracked by Minitrack and radar to predict the time and area of re-entry.

Primary mission objectives of SA-6 will be:

- Launch vehicle propulsion, structural, and control demonstration.
- First active closed loop ST-124 guidance flight.
- First flight of the Apollo Spacecraft and Saturn Launch Vehicle configuration.
- Determine structurally the launch escape tower separation characteristics.
- S-I Stage and S-IV Stage separation and ignition.

Secondary mission objectives of SA-6 will be:

- Visual documentation by movie cameras of internal vehicle functions and stage separation.
- Demonstrate Apollo Spacecraft launch and environmental parameters.
- Demonstrate compatibility of research and development communications and instrumentation between the space vehicle and ground.

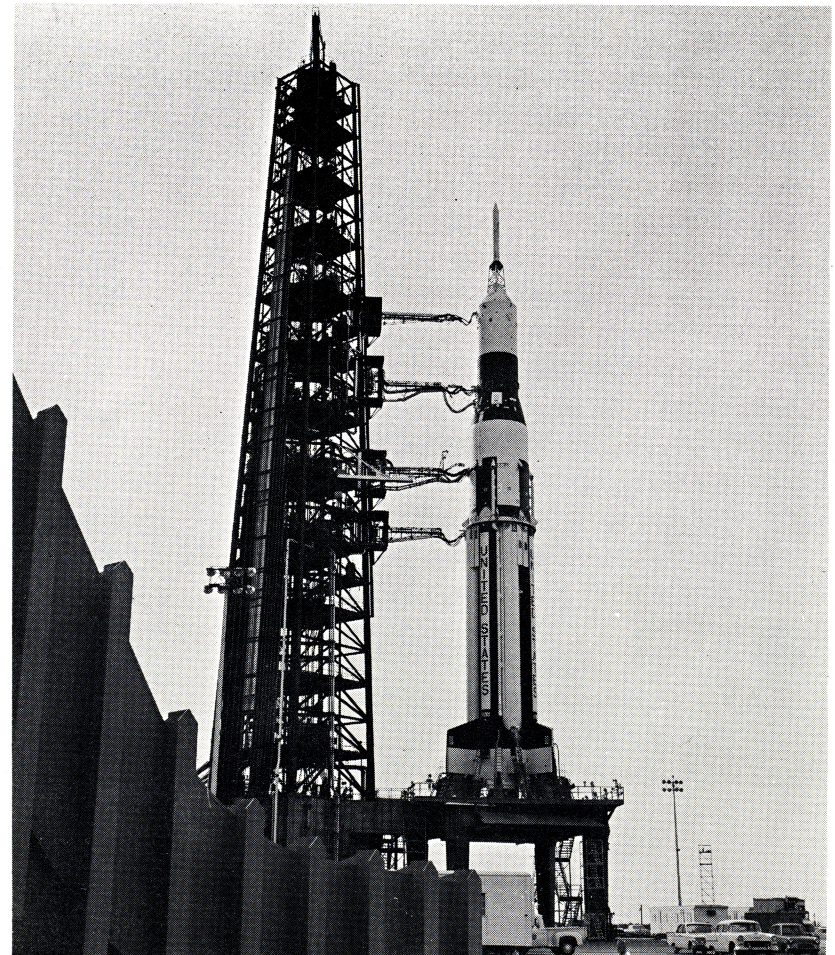

STATISTICS

SA-6 is 190 feet 6 inches high with a maximum diameter of 21 feet 5 inches. Its dry weight is 143,319 pounds, loaded it weighs 1,133,107 pounds, and liftoff weight is 1,123,719 pounds. SA-6 consists of the: S-I, S-IV, Instrument Unit, and Apollo Spacecraft.

	Manufacturer
S-I	Marshall Space Flight Center
S-IV	Douglas Aircraft
Instrument Unit	Marshall Space Flight Center
Apollo Spacecraft	North American Aviation
RL10A-3 Engine	Pratt and Whitney
H-1 Engine	Rocketdyne
TX-280	Thiokol

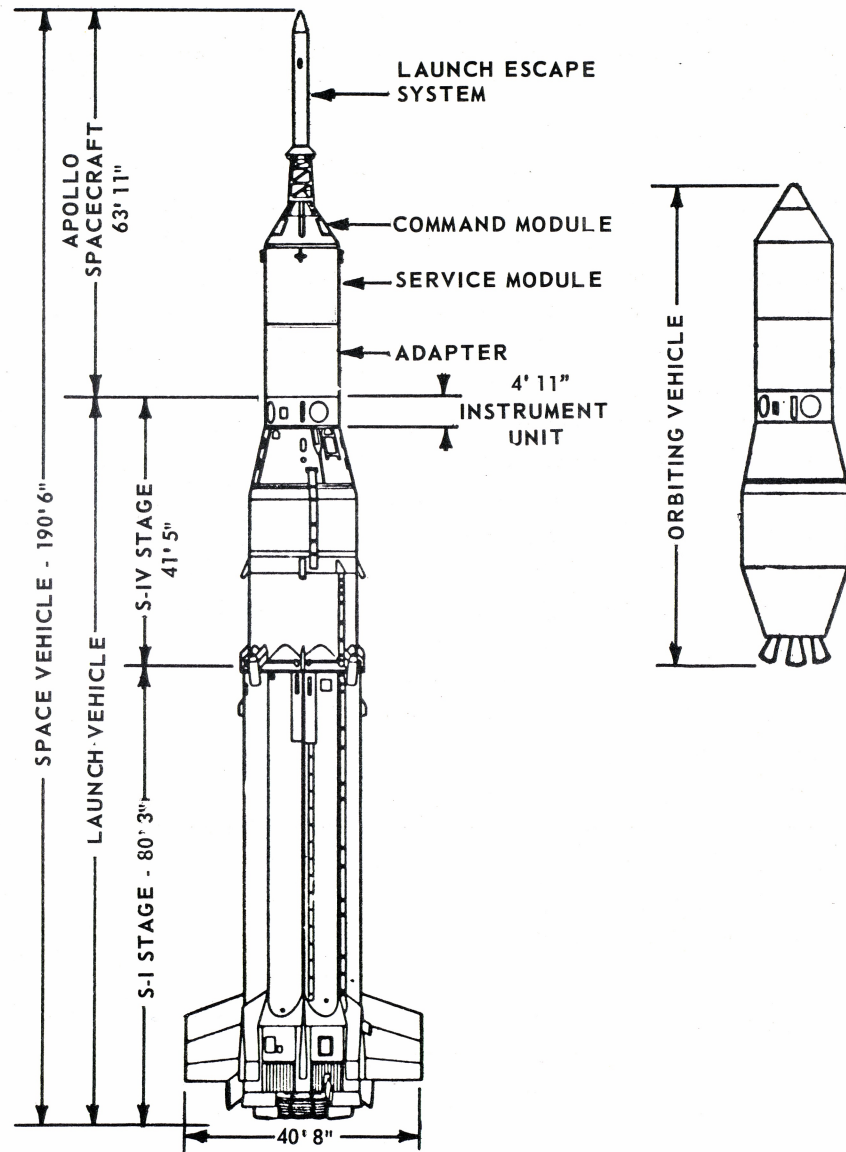

APOLLO SPACECRAFT

The SA-6 Apollo Spacecraft is composed of a Launch Escape System (LES) with a live jettison motor, a heavy walled Command Module (CM), and a Service Module (SM). Combined length is 63 feet 11 inches with a maximum diameter of 12 feet 10 inches and a total weight of approximately 17,000 pounds.

The CM configuration consists of a crew compartment, main hatch, forward access way, aft heat shield, forward compartment cover, communications and instrumentation systems, and an environmental control system. For the SA-6 flight, the crew compartment shall contain instrumentation, an electrical power system, and ballast. An aluminum alloy main hatch which bolts to the module structure provides ingress and egress to the CM. Access to the forward compartment shell provides for telemetry antenna installation. The forward access way, welded to the forward bulkhead, consists of a tubular aluminum structure with a bolt-on cover.

The aft heat shield, which will provide re-entry protection of the CM on later missions, consists of inner and outer glass laminated skins with an aluminum honeycomb core. Four adjustable struts, attached to the inside of the CM aft end, provide support for the heat shield.

The communications and instrumentation systems for SA-6 consist of telemetry circuits and sensor devices which will provide the essential design criteria for design and modification of future Apollo Spacecraft.

The environmental control system provides cool air to maintain a constant internal ambient temperature range of 80 to 90 degrees in the CM.

The boiler plate SM provides housing for various instrumentation systems. The semi-monocoque module construction, utilizing aluminum, provides stress distribution and load control during flight, launch, and shipment phases of the Apollo project. The SM connects to the CM through a non-functional separation mechanism. Bolts attach the SM extension to the SM.

A semi-monocoque aluminum adapter structure attached with bolts to the SM and Instrument Unit provides payload adaption to the Instrument Unit forward end.

The LES used on SA-6 will be identical to the later LES systems except that the LES motor and kicker motor will be inert. The launch escape tower will be jettisoned after S-IV ignition by the jettison motor. A mechanical tower release mechanism will release all four legs of the LES tower simultaneously. A semi-monocoque structural skirt attaches the launch escape motor to the tower and transfers structural loads to the tower truss.

The nose cone provides an aerodynamic fairing to the forward end of the LES and supports approximately 1,500 pounds of ballast, which simulates the ultimate Apollo full load.

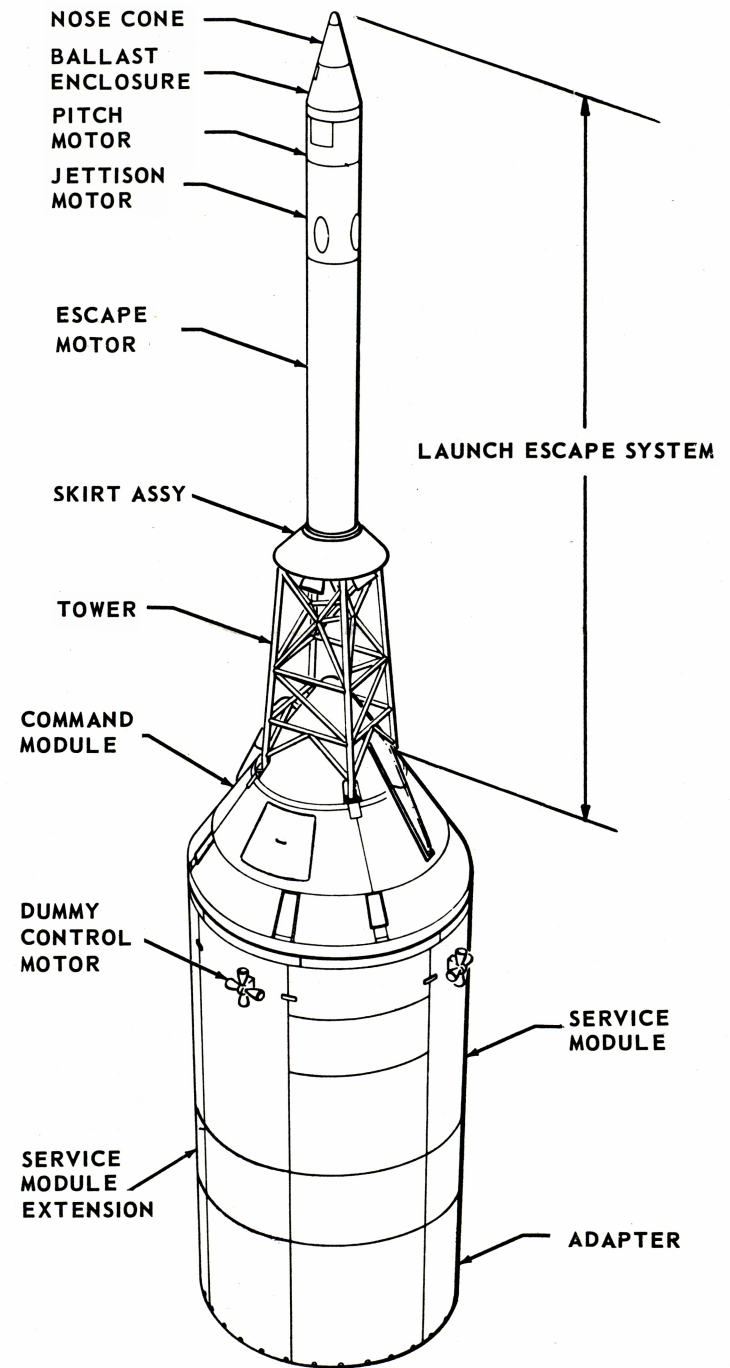

APOLLO SPACECRAFT

INSTRUMENT UNIT

The Instrument Unit is 4 feet 11 inches high and 12 feet 10 inches in diameter. The stage weighs 5,654 pounds. It consists of four 40-inch diameter tubes which extend radially from a 70-inch vertical tube to the external skin. These five tubes, pressure and temperature controlled, contain most of the guidance and control equipment, tracking aids, and associated instrumentation. Total height of the unit is 4 feet 11 inches.

The developmental ST-124 Stabilized Platform, Guidance Signal Processor, and Digital Guidance Computer carried as passengers in the Instrument Unit on previous launch vehicles will become active and take over for the ST-90S Stabilized Platform during the second stage portion of the SA-6 flight. The function of a guidance and control system can be divided into three parts: (1) the generation of information concerning the instantaneous state of the vehicle, (2) evaluation of this information according to the guidance mode for the purpose of generating steering decisions, and (3) stabilization of the vehicle according to information received from the guidance mode.

Electronic equipment carried in the Instrument Unit includes a Mistram Transponder, Azusa Transponder, C-Band Radar Beacon, Odop Transponder, Radar Altimeter, and Horizon Sensor. There are four telemetry subsystems; PCM-FM, SS-FM, and two FM-FM systems.

COMPARTMENT 1
ST 905

COMPARTMENT 2
ST 124

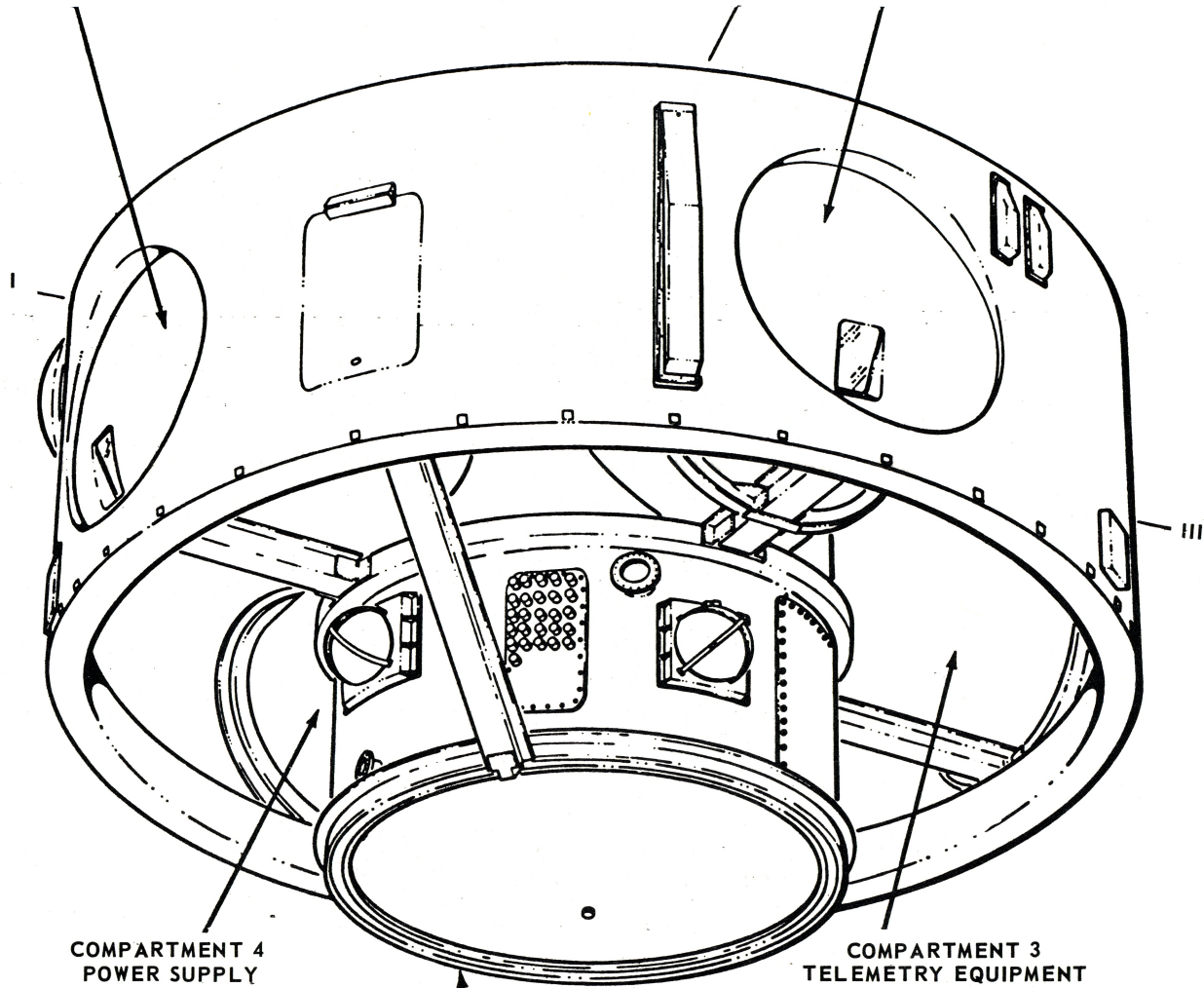

COMPARTMENT 4
POWER SUPPLY

COMPARTMENT 3
TELEMETRY EQUIPMENT

GUIDANCE CONTROL
EQUIPMENT

INSTRUMENT UNIT

S-IV STAGE

The second stage, S-IV, is 41 feet 5 inches high and 18 feet 4 inches in diameter. It weighs 13,678 pounds dry and 114,178 pounds loaded. The 100,500 pounds propellant load consists of 16,916 pounds of liquid hydrogen and 83,584 pounds of liquid oxygen.

The stage develops 90,000 pounds thrust from six Pratt & Whitney RL-10A3 engines, rated at 15,000 pounds each. Total burning time is 483 seconds. The oxidizer to fuel ratio is about 5 to 1. The engines, canted six degrees, can swivel four degrees in a square pattern for control.

To insure proper propellant positioning at separation, the S-IV uses four Thiokol TX 280 ullage rockets which develop 4,800 pounds of thrust each and burn for 3.9 seconds. These ullage rockets are jettisoned after S-IV engine start.

The S-IV structure is an insulated aluminum cylinder closed forward and aft by hemispheric domes and divided by a bulkhead, also a dome, attached near the periphery of the aft dome and roughly parallel to the forward dome. This bulkhead is a fiberglass core bonded between one-eighth inch sheets of aluminum. The forward tank holds 28,000 gallons of liquid hydrogen and the aft tank holds 8,750 gallons of liquid oxygen.

Both tanks are pressurized with helium gas on the ground and during the boost phase, the hydrogen tank to about 35 psia and the oxygen tank to about 45 psia. After S-IV engine ignition, hydrogen gas is used to pressurize the hydrogen tank.

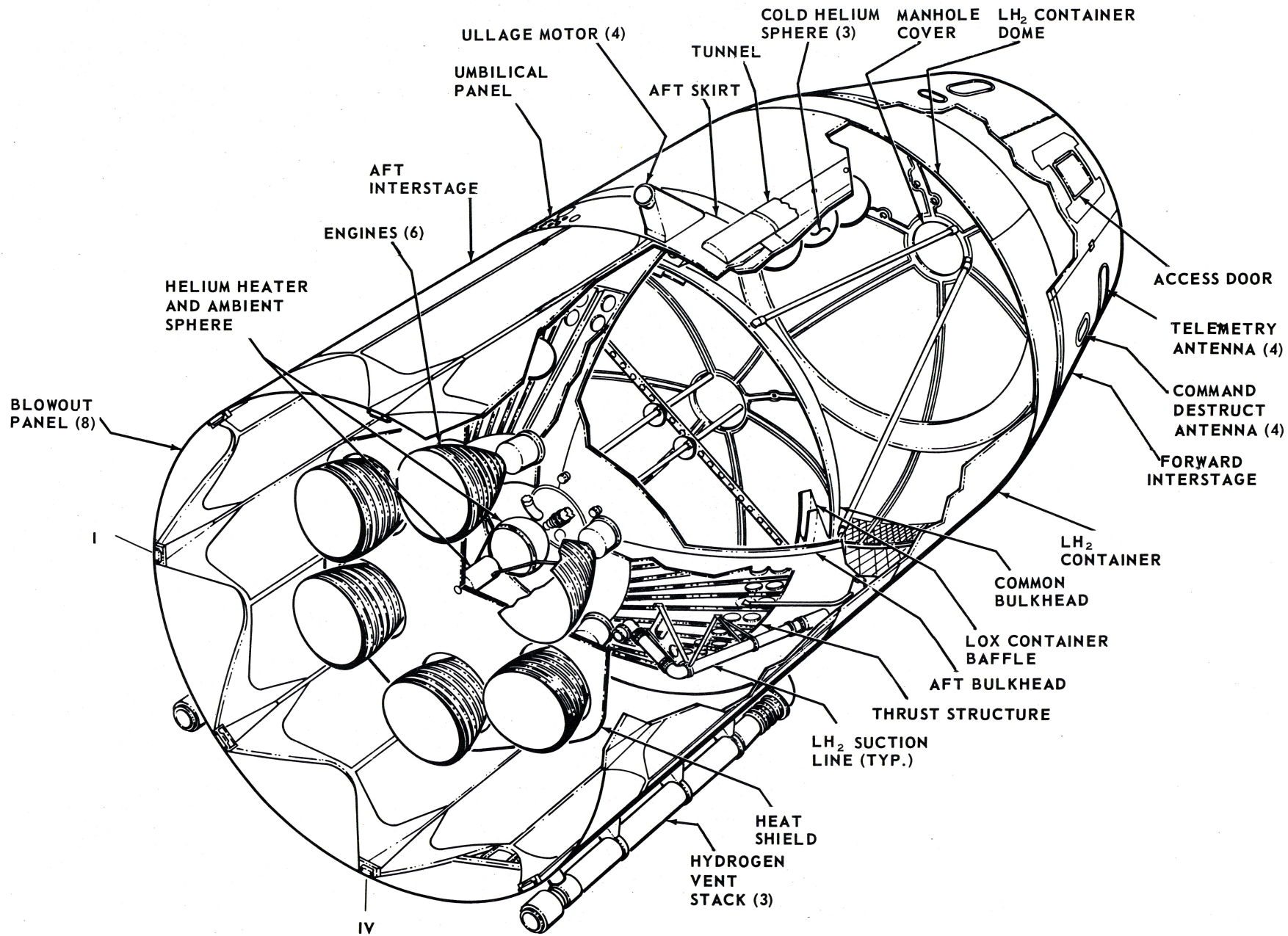

S-IV STAGE

S-I STAGE

The first stage, S-I, is 80 feet 3 inches high and 21 feet 5 inches in diameter (the diameter including the fins is 40 feet 8 inches). S-I weighs 106,000 pounds dry and 995,598 pounds loaded. The propellant load of 889,598 pounds is made up of 273,230 pounds of RP-1 and 616,368 pounds of liquid oxygen.

The S-I develops approximately 1,500,000 pounds of thrust from eight Rocketdyne H-1 engines, rated at 188,000 pounds each. Total burning time is approximately 146 seconds. The mixture ratio of oxidizer to fuel is about 2.26 to 1.

The four inner engines are canted three degrees; the four outer engines are canted six degrees and can swivel eight degrees in a square pattern for control.

To insure separation, four Aerojet MB-1 Retrorockets are used which develop 37,000 pounds of thrust each and burn for 2.15 seconds.

Eight propellant tanks 70 inches in diameter and 606 inches high are clustered about a central tank 105 inches in diameter and 607 inches high. The central tank and four alternate outer tanks hold a total of 64,200 gallons of liquid oxygen. The other four outer tanks hold a total of 41,000 gallons of RP-1 fuel.

The RP-1 tanks are pressurized to 17 psig with gaseous nitrogen. The oxygen tanks are pressurized to 47 psig with helium for ground operations and with gaseous oxygen during flight.

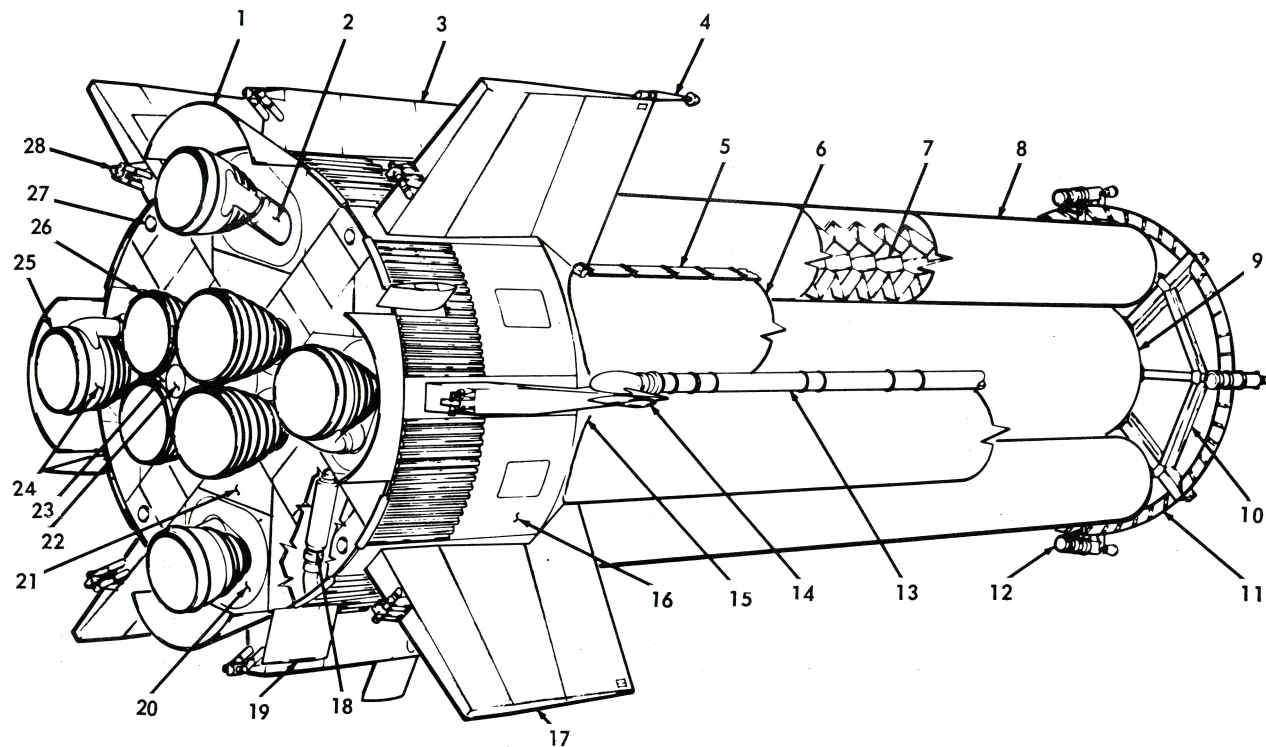

ITEM	NOMENCLATURE
1	ENGINE SKIRT (4)
2	OUTBOARD ENGINE HEAT EXCHANGER (4)
3	STUB FIN (4)
4	ANGLE OF ATTACK INDICATOR (2; SA-7, 9 & 10)
5	CABLE ROUTING DUCT (4)
6	FUEL CONTAINER (4)
7	ANTISLOSH BAFFLES (IN EACH CONTAINER)
8	70-IN. DIAMETER LOX CONTAINER (4)
9	105-IN. DIAMETER LOX CONTAINER
10	SPIDER BEAM
11	45° SHROUD ASSEMBLY
12	RETROMOTOR (4)
13	HYDROGEN VENT LINE (3)
14	HYDROGEN EXHAUST DUCT ASSEMBLY (3)

ITEM	NOMENCLATURE
15	CONICAL FAIRING (8)
16	TAIL SECTION ASSEMBLY SHROUD
17	FIN (4)
18	INBOARD ENGINE HEAT EXCHANGER (4)
19	INBOARD ENGINE TURBINE EXHAUST DUCT (4)
20	FLAME CURTAIN (4)
21	HEAT SHIELD PANEL ASSEMBLY (4)
22	ACCESS CHUTE
23	FLAME SHIELD ASSEMBLY
24	ASPIRATOR (4)
25	OUTBOARD ENGINE (4)
26	INBOARD ENGINE (4)
27	WATER QUENCH DISCONNECT (4)
28	SUPPORT AND HOLDDOWN POINT (8)

S-I STAGE

INSTRUMENTATION

Cameras

Eight 16mm camera capsules, mounted in the S-I/S-IV interstage, will be ejected 20 seconds after separation. Two cameras, using fibre optics bundles, will record liquid oxygen motion in the center and number three tanks. The other cameras will record S-IV ullage rocket ignition, S-I retrorocket ignition, S-IV engine ignition, physical separation, S-IV engine prestart and LOX-SOX disposal, and booster tumbling rate. Paraballoons will be used for deceleration and flotation of the capsules. SARAH beacons and stroboscopic lights will be used as recovery aids.

Two on-board television cameras will transmit real time coverage of equipment operations located in the engine compartment and staging sequence of the S-I and S-IV.

Telemetry

SA-6 carries 17 telemetry links which will record more than 1,400 measurements. Fourteen links will be carried on the launch vehicle and three links on the spacecraft.

ELECTRONIC DATA ACQUISITION EQUIPMENT		
System	Equipment Type	Location
Television	Camera and Transmitter	S-I Stage
Azusa	Transponder	Instrument Unit
ODOP	Transponder	Instrument Unit
Mistram	Transponder	Instrument Unit
Radar Altimeter	Transmitter and Receiver	Instrument Unit
Horizon Sensor	Infrared Sensors	Instrument Unit
C-Band Radar	Transponder	Instrument Unit
Minitrack	Beacon	Instrument Unit
C-Band Radar	Transponder	Spacecraft
Sarah	Beacon	Cinecamera Pods

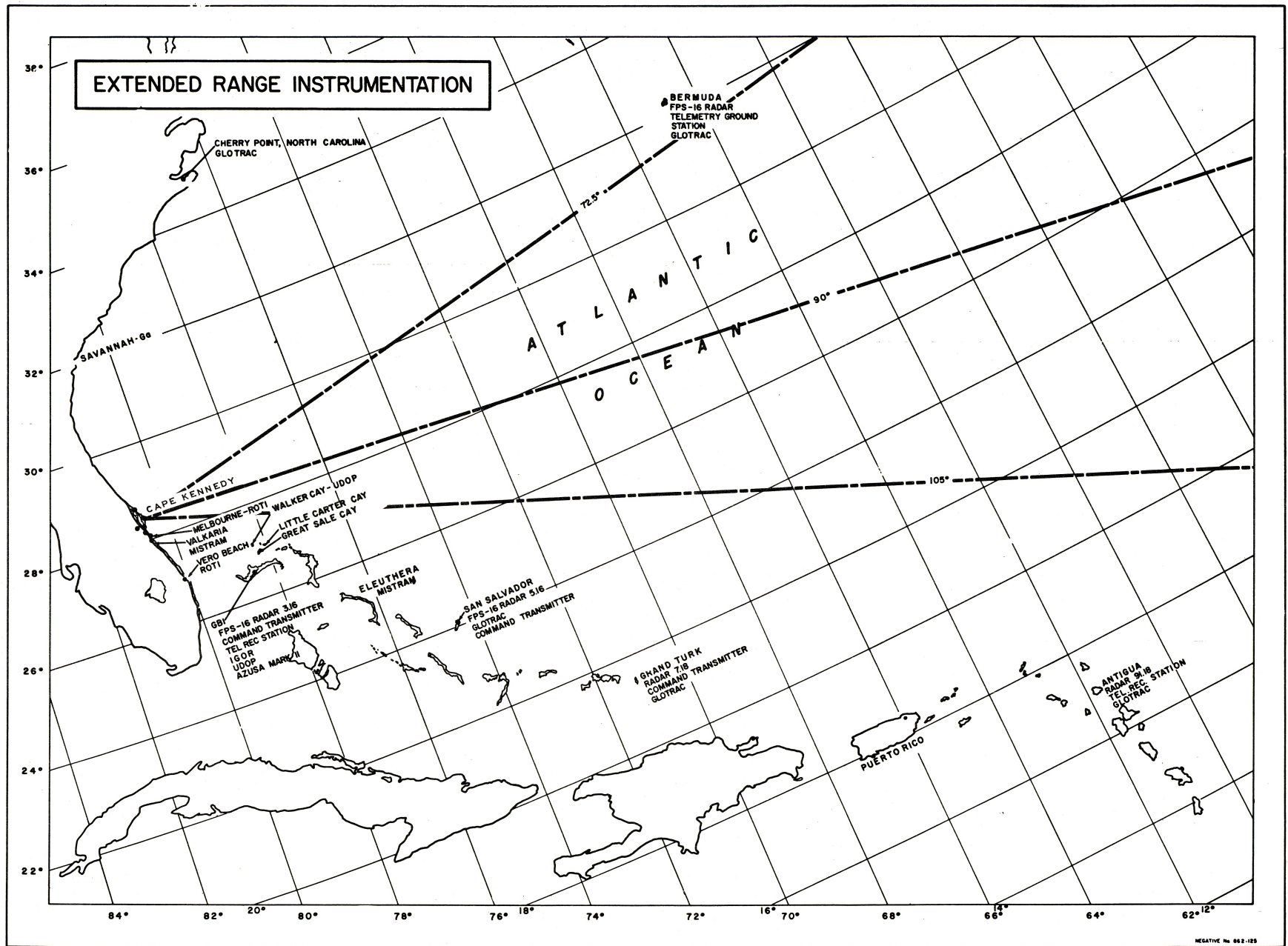

EXTENDED RANGE INSTRUMENTATION

SATURN/APOLLO SA-6 COUNTDOWN

F - 1 DAY

LAUNCH DAY

BUILD
IN
HOLD

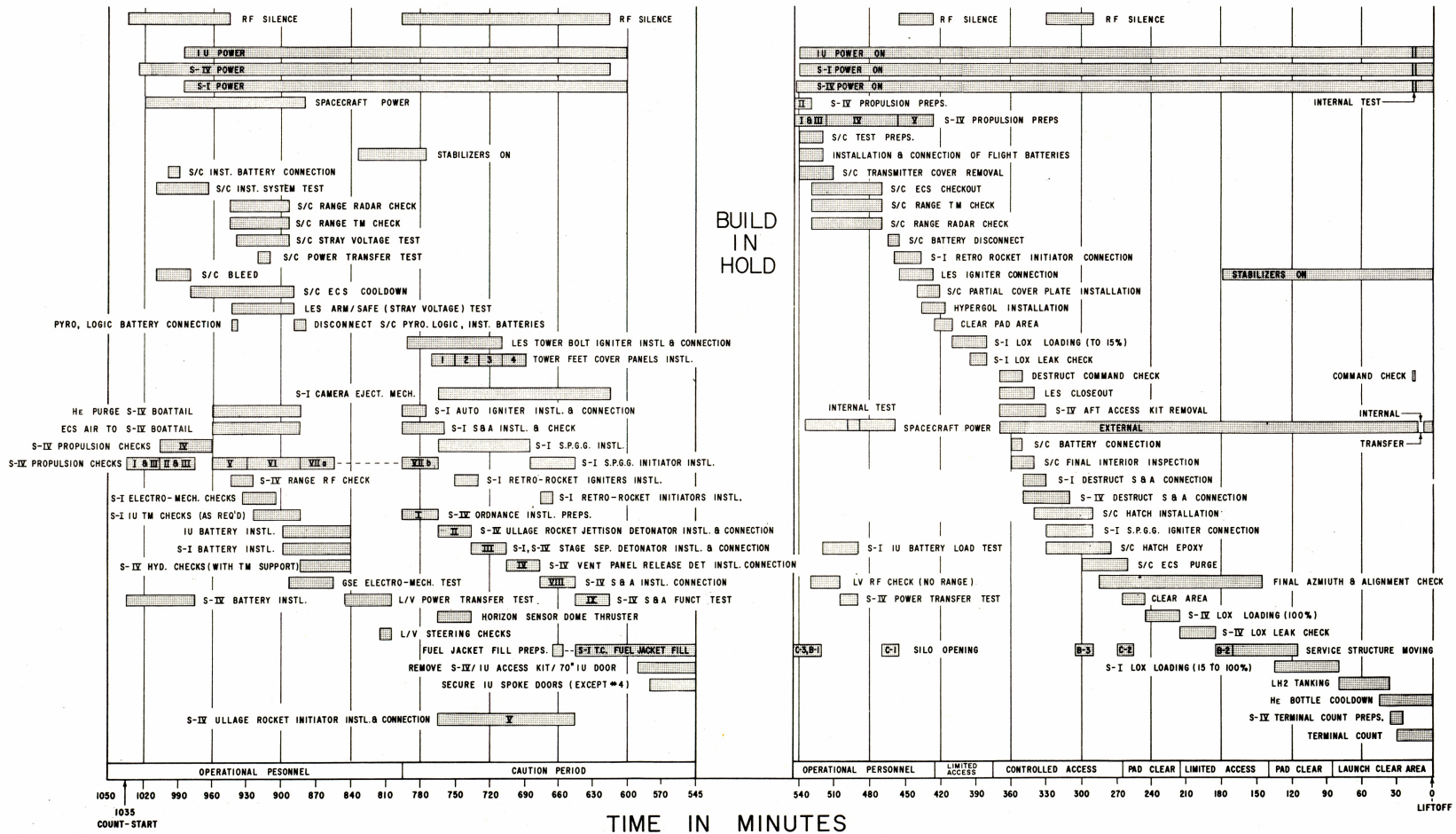

LAUNCH SEQUENCE AND TRAJECTORY

SA-6 will be launched from Complex 37B on an azimuth of 90 degrees and, after liftoff, will roll to an azimuth of 105 degrees. Programmed tilt will begin at T+15 seconds and continue until T+135 seconds. At this time, SA-6 will be tilted 63 degrees.

At S-I cutoff, SA-6 will have a velocity of about 5,200 miles per hour, an altitude of 48 miles, and a slant range of 65 miles. After S-I/S-IV separation a second tilt program is initiated to achieve the desired final trajectory. Under nominal conditions the camera recovery area is about 515 miles downrange. At T+630 seconds the S-I Stage will impact approximately 483 miles downrange; S-IV cutoff will occur almost simultaneously. Final velocity of the S-IV Stage and Spacecraft will be 16,600 miles per hour. The slant range at orbit injection will be about 1,300 miles.

Sequence of Events (Time in seconds)	
T-3	Ignition Command
T-0	Launch Commit
	Holddown Release
	Liftoff
T+8 to T+13	Roll to 105 Degrees
T+15	Start Programmed Tilt
T+113	S-IV LH ₂ Chilldown
T+138	S-IV LOX Chilldown
	Blowout Panels Open
*T+140	S-I Inboard Engine Cutoff
	LOX-SOX Valves Open
*T+146	S-I Outboard Engine Cutoff
T+146.3	S-IV Ullage Rockets Fire
T+147.1	Separation Command
T+147.4	S-I Retrorockets Fire
T+148.1	S-IV Start Solenoid Energized
	Stage Separation of Ten Feet
	Fuel Valves Open
	S-IV Engine Ignition
T+158.4	Escape Tower Jettison
T+160.4	Switch from ST-90S to ST-124
T+166	Camera Ejection
*T+627.5	S-IV Engine Cutoff

* Approximate

LAUNCH COMPLEX 37

SA-6 will be launched from Pad B of Launch Complex 37. The 300-foot square pad supports the launch pedestal, umbilical tower, and service structure. The launch pedestal is a 55-foot square, mild steel table.

The umbilical tower, a 268-foot high steel-trussed structure, can be extended, if necessary, to 320 feet for use with future Saturn vehicles. The 300-foot high, seven million pound service structure provides access for servicing and checkout of the vehicle.

A circular-domed, reinforced-concrete building, approximately 0.4 mile from the launch pads, known as the "blockhouse," functions as the launch control center.

Control of the countdown procedures and pre-launch operations comes from the blockhouse. Blockhouse instrument panels and consoles give a complete and thorough indication of all vehicle systems and ground support equipment during the pre-launch, launch, and flight phases of SA-6.

An observation balcony on top of the blockhouse provides a pre-launch view of activities on the launch pads.

Various pre-launch operations within the blockhouse include calibration, checkout, fuel and LOX fill and drain, water quench operation, pneumatic systems control, electrical power and distribution, and control of the gaseous helium and nitrogen systems.

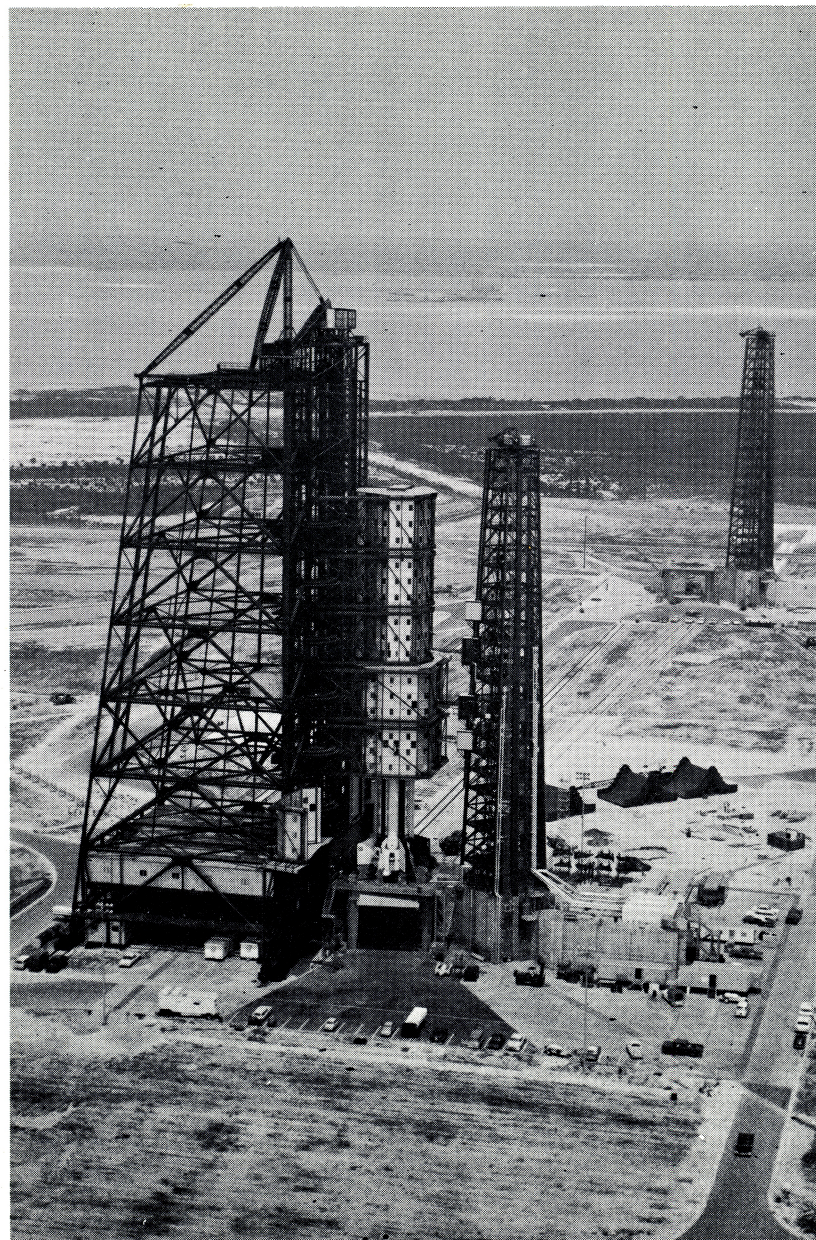

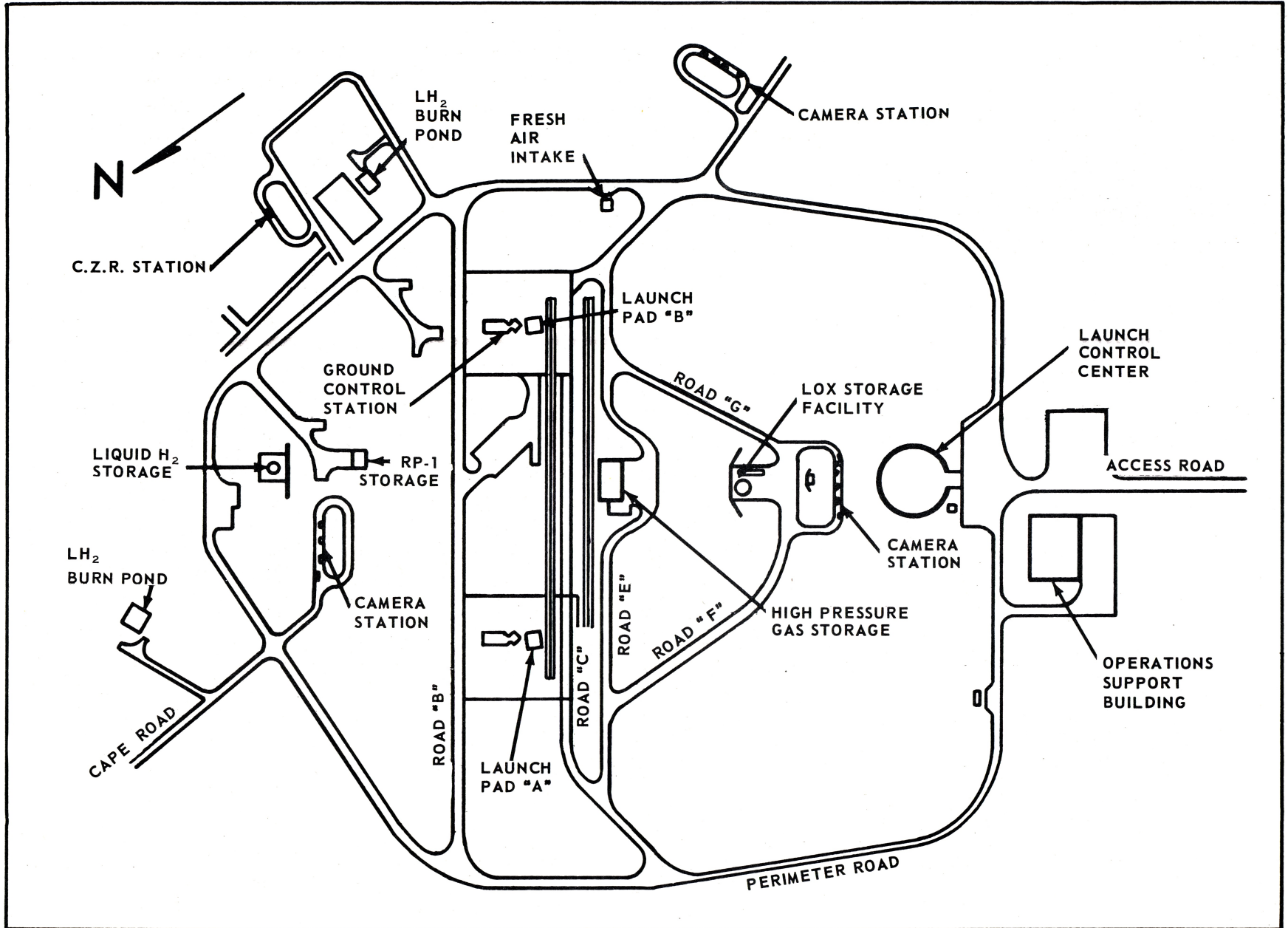

LAUNCH COMPLEX 37

LIQUID HYDROGEN FACILITY

Hydrogen is the first new liquid fuel to be used in U.S. rockets in ten years. At Complex 37, liquid hydrogen is transferred from a 125,000 gallon spherical storage tank to the S-IV Stage by remote control. During transfer, liquid hydrogen flows under 42 pounds per square inch pressure at a rate of 2,000 gallons per minute.

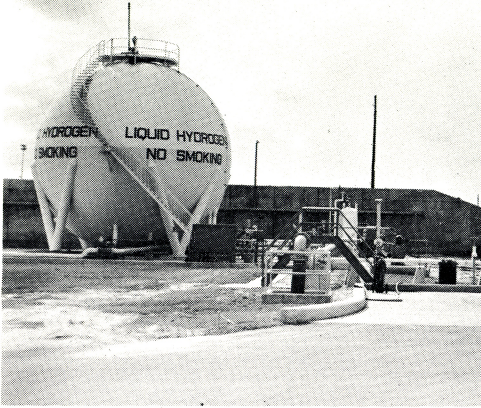

LIQUID OXYGEN FACILITY

There are two storage tanks at the Liquid Oxygen Facility; one with a capacity of 125,000 gallons and the other 28,000 gallons. Centrifugal pumps transfer LOX to the S-I Stage at a rate of 2,500 gallons per minute and 1,000 gallons per minute to the S-IV Stage.

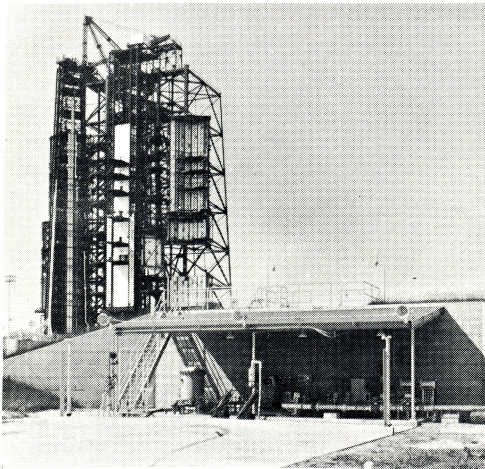
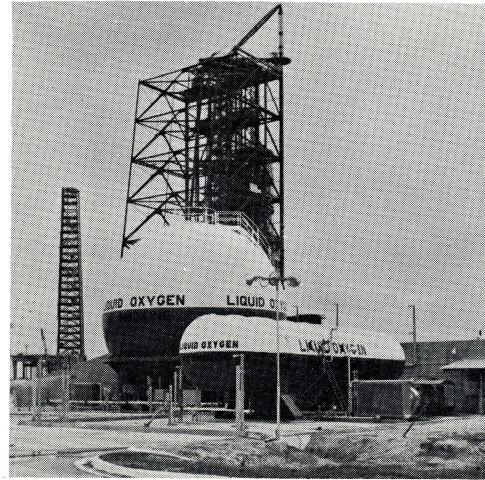

RP-1 FUEL FACILITY

RP-1 fuel is stored at Complex 37 in a 43,500-gallon tank. The remotely controlled fueling sequence transfers RP-1 fuel to the S-I Stage at a rate of 2,000 gallons per minute.



JOHN F. KENNEDY SPACE CENTER, NASA, COCOA BEACH, FLORIDA

[HTTP://HEROICRELICS.ORG](http://heroicrelics.org)

